

NACHI

PVS SERIES
VARIABLE VOLUME PISTON PUMP

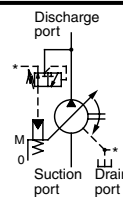

PVS Series Variable Volume Piston Pumps

8.0 to 45.0cm³/rev
21MPa

A
Piston Pumps

- ❖ Design No. 30 is applied on PVS-0B to make the pump more compact and lighter, and reduce noise.
- ❖ Production of PVS-3B has been discontinued. Use PZS-3B.
- ❖ Pressure adjustment 3 type has been added to PVS-1B-22 and PVS-2B-45. (Design No. 20 is applied only on PVS-2B-45*3.)

Features

Energy-saving Type with Drastically Reduced Loss

A NACHI-proprietary semi-circular barrel swash plate that receives pressure on its surface ensures a stable discharge volume at all times. This eliminates excess

discharge volume, and enables the effective use of power corresponding to the load cycle.

This "energy-saving type" conserves energy, reduces power loss, and helps to reduce hydraulic costs.

Silent Type That Demonstrates Its Power Quietly

Proprietary low-noise mechanisms are incorporated on the shoe, swash plate, valve plate, and other locations to ensure silent operation. In particular, a semi-circular barrel swash plate stabilizes operation characteristics to ensure silent operation.

Specifications

Model No.	Volume cm ³ /rev	Discharge volume at no-load ℓ /min				Pressure adjustment range MPa {kgf/cm ² }	Permitted peak pressure MPa {kgf/cm ² }	Rotating speed min ⁻¹		Mass kg
		1000min ⁻¹	1200min ⁻¹	1500min ⁻¹	1800min ⁻¹			Min.	Max.	
PVS-0B-8*0-30 1 2 3	8.0 (3.0 to 8.0)	8.0	9.6	12.0	14.4	2 to 3.5 {20.4 to 35.7} 2 to 7 {20.4 to 71.4} 3 to 14 {30.6 to 143} 3 to 21 {30.6 to 214}	25 {255}	500	2000	7.7
PVS-1B-16*0(*)-12 1 2 3	16.5 (5.0 to 16.5)	16.5	19.8	24.7	29.7	2 to 3.5 {20.4 to 35.7} 2 to 7 {20.4 to 71.4} 3 to 14 {30.6 to 143} 3 to 21 {30.6 to 214}	25 {255}	500	2000	10.5
PVS-1B-22*0(*)-12 1 2 3	22.0 (7.0 to 22.0)	22.0	26.4	33.0	39.6	2 to 3.5 {20.4 to 35.7} 2 to 7 {20.4 to 71.4} 3 to 14 {30.6 to 143} 3 to 21 {30.6 to 214}	25 {255}	500	2000	10.5
PVS-2B-35*0(*)-12 1 2 3	35.0 (8.0 to 35.0)	35.0	42.0	52.5	63.0	2 to 3.5 {20.4 to 35.7} 2 to 7 {20.4 to 71.4} 3 to 14 {30.6 to 143} 3 to 21 {30.6 to 214}	25 {255}	500	2000	21
PVS-2B-45*0(*)-12 1 2 3(*)-20	45.0 (11.0 to 45.0)	45.0	54.0	67.5	81.0	2 to 3.5 {20.4 to 35.7} 2 to 7 {20.4 to 71.4} 3 to 14 {30.6 to 143} 3 to 21 {30.6 to 214}	25 {255}	500	2000	21

Note) Direction of rotation is clockwise when viewed from the shaft end.

- Handling
- Cautions during Pump Installation and Piping

- 1 Use flexible couplings for connecting the pump shaft to the drive shaft, and prevent a radial or thrust load from being applied on the pump shaft.
- 2 For centering of the pump shaft, limit the eccentricity between the drive shaft and hydraulic pump shaft to 0.05 mm, and keep the angle error within 1°.
- 3 Set the clamping length of couplings and hydraulic pump shafts so that it is within at least 2/3 or more of the coupling width.
- 4 Use a sufficiently rigid pump mounting base.
- 5 Set the pressure on the pump suction side to -0.03 MPa or more (suction port flow velocity within 2 m/sec).
- 6 Raise part of the drain piping to above the topmost part of the pump body, and

insert the return section of the drain piping into the hydraulic operating fluid. Also, observe the values in the following table to limit the drain back pressure to 0.1 MPa.

Item	Model No.	PVS-0B PVS-1B	PVS-2B
Pipe joint size		3/8" or more	1/2" or more
Pipe I.D		φ7.6 mm dia or more	φ12 mm dia or more
Pipe length		1m or less	1m or less

- Management of Hydraulic Operating Fluid

- 1 Use good-quality hydraulic operating fluid, and use within a kinematic viscosity range of 20 to 200 mm²/sec during operation. Use an R&O type and anti-wear hydraulic fluid of ISO-VG32 to 68. The optimum kinematic viscosity during operation is 20 to 50 mm²/sec.

- 2 The operating temperature range is 5 to 60°C. When the oil temperature at start-up is 5°C or less, warm up the hydraulic pump by low-pressure, low-operation speed operation until the oil temperature reaches 5°C.
- 3 Provide a suction strainer with a filtering grade of about 100μm (150 mesh). Be sure to provide a return line filter of grade 20μm or less on the return line to the tank. (When the hydraulic pump is used at a high pressure of 14 MPa or more, we recommend providing a filter of 10μm or less.
- 4 Manage the hydraulic operating fluid so that contamination is maintained at class NAS10 or lower.
- 5 Use hydraulic operating fluid within an operating ambient temperature of 0 to 60°C.

(continued on following page)

● Cautions at Startup

- 1 Before you start pump operation, fill the pump body with clean hydraulic operating fluid via the lubrication port.
- 2 An unload is required when the motor is started under condition $\lambda-\Delta$. Consult your agent regarding the circuit.
- 3 Make sure that the pump operates in the direction of rotation the same as that indicated by the arrow on the pump body.

Model No.	Injection amount cm ³
PVS-0B-8	220
PVS-1B-16, 22	300
PVS-2B-35, 45	650

4 Air entering the pump or pipes may cause noise or vibration. At startup, set the pump discharge side to a no-load state, and operate the pump in the inching mode to release any air in the pump or pipes.

5 Provide an air bleed valve in circuits where it is difficult to release air at start-up. (See "IP Pumps" on page C-13.)

● How to Set Pressure and Discharge Volume

The default pump discharge volume is set to "maximum" and default discharge pressure is set to "minimum". Change the discharge volume and discharge pressure settings according to your particular operating conditions.

[Pressure adjustment]
Turning the pressure adjusting screw CW increases the pressure.

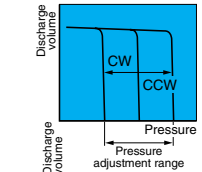

[Discharge volume adjustment]
Turning the flow rate adjusting screw CW decreases the discharge volume.

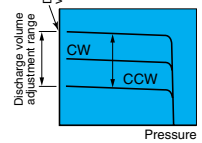

Note)

- For details regarding the relationship between flow rate adjustment length l and pump capacity q , see the tables provided in the installation dimension drawings for each of the pumps.
- Firmly tighten the lock nuts after you have finished adjustments.

[Note]

● Variable control mechanism

Standard type

N* : Pressure compensation type (manual mode)

Option type

P* : Pressure compensation type (remote control mode)

N*Q* : 2-pressure, 2-flow rate control

R^AS[⊕] : Solenoid cutoff control

W^AS[⊕] : 2-pressure control

RQ^AS[⊕] : 2-pressure, 2-flow rate control w/ solenoid cutoff

C^AS[⊕] : 2-cutoff control

● * : Pressure adjustment range

0 : 2 to 3.5MPa {20.4 to 35.7kgf/cm²}

1 : 2 to 7MPa {20.4 to 71.4kgf/cm²}

2 : 3 to 14MPa {30.6 to 143kgf/cm²}

3 : 3 to 21MPa {30.6 to 214kgf/cm²}

● ⊕ : Applicable to solenoid specifications A, S

A⊕ : SA-G01

S⊕ : SS-G01

1 : 100V 50/60Hz

2 : 200V 50/60Hz

3 : DC12V

4 : DC24V

Explanation of model No

PVS - 1 B - 16 N 2 - (*) - 12

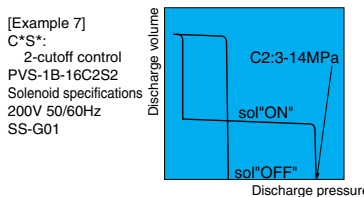
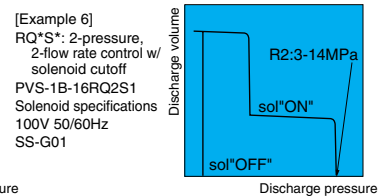
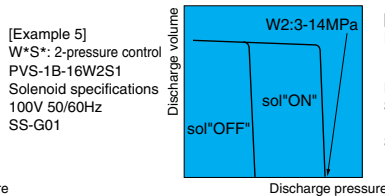
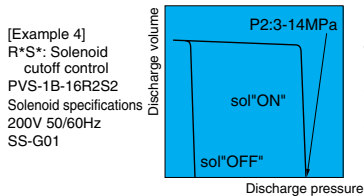
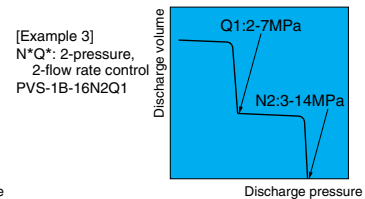
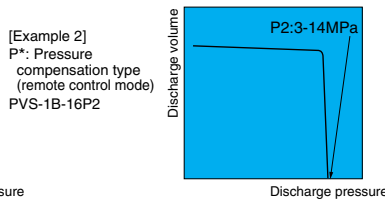
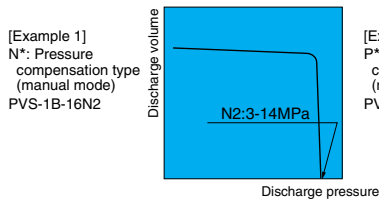
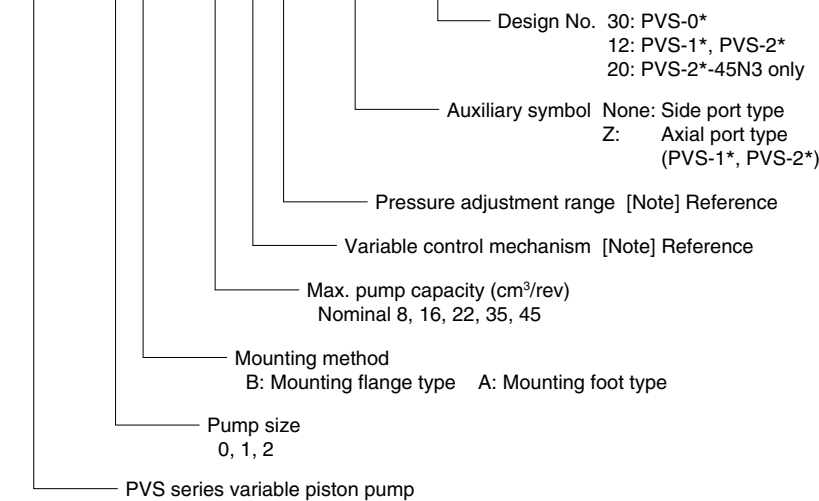

■ NQ, RS, WS, RQS and CS types are not available for the PVS-0B-8.

■ NQ, RQS and CS types are not available for the PVS-1B-¹⁶/₂₂-Z and PVS-2B-³⁵/₄₅-Z.

Variable Control Mechanisms

Standard type

Symbol	External View	Characteristics	Hydraulic Circuit	Explanation
N				<p>Pressure compensation type (manual system)</p> <p>When the discharge pressure reaches the preset volume set by the pressure compensator, the discharge volume is automatically reduced to hold the pressure at the set pressure.</p>

Option type

P				<p>Pressure compensation type (remote control mode)</p> <p>This mode demonstrates the same characteristics as the manual mode. The discharge pressure can be adjusted by external pilot pressure. The discharge volume can be adjusted manually. Note 2)</p>
NQ				<p>2-pressure, 2-flow rate control type</p> <p>The discharge volume changes in two stages by the pump's built-in sequence valve. This allows conventional high/ low pressure control to be performed on a single pump unit, and save energy in the hydraulic circuit.</p>
RS (RA)				<p>Solenoid cutoff control type</p> <p>A solenoid valve for unload is integrated into the pressure compensation type to minimize energy loss when pump output is not required. Only a slight amount of heat is generated.</p>
WS (WA)				<p>2-pressure control type</p> <p>Two pressure compensation types can be obtained by switching the solenoid valve ON/OFF. Two types of output control are possible with the actuator set to a constant speed.</p>
RQS (RQA)				<p>2-pressure, 2-flow rate control type w/ solenoid cutoff</p> <p>The discharge volume can be changed in two stages by the sequencer valve and solenoid valve for unload mounted on the pump, and unloading is possible when pressure oil is not required.</p>
CS (CA)				<p>2-cutoff control type</p> <p>Two types of pressure - flow rate characteristics can be obtained by the solenoid valve and cylinder mounted on the pump.</p>

Note 1) Many other variable control mechanism are also available in addition to those in the above table. Please consult your agent for details.

Note 2) We recommend ZR-T02*-5895* as the remote control valve. For details, consult your agent. Prevent the pipe volume up to the remote control valve from falling below 150cm³.

Pressure Compensation Type

Manual mode: standard type

PVS-0B-8N*-30

Installation Dimension Drawing

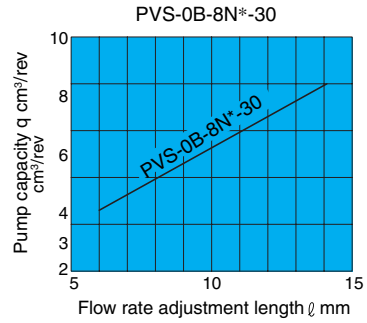
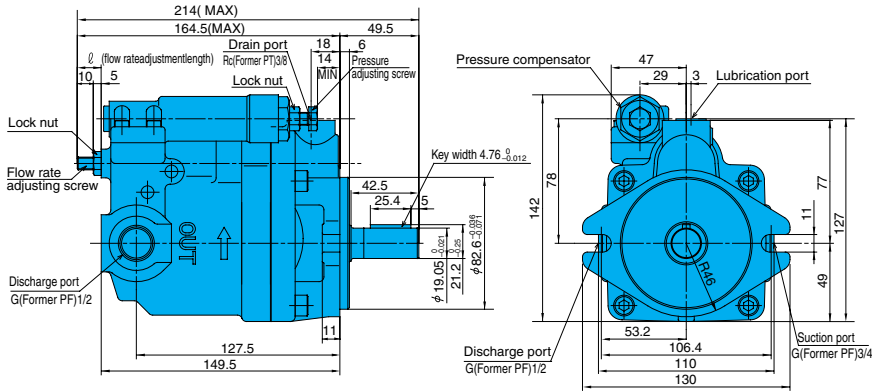

Set a flow rate adjustment length within the above range. Oil will leak if the pump is operated below the adjustment range lower limit.

Cross-sectional Drawing

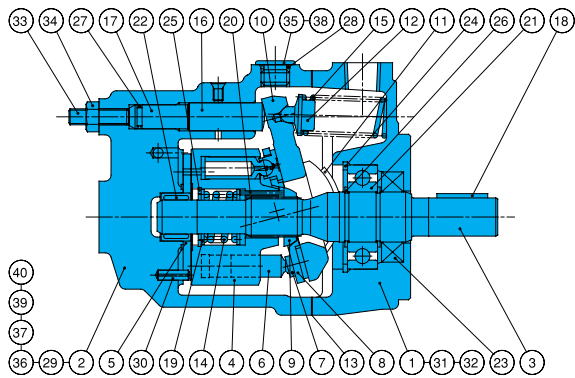

Part No.	Part Name	Part No.	Part Name	Part No.	Part Name
1	Body	15	Spring S	29	Parallel pin
2	Case	16	Control piston	30	Spring pin
3	Shaft	17	Guide pin	31	Hexagon socket head bolt
4	Cylinder barrel	18	Parallel key	32	Cross-recessed countersunk head screw
5	Valve plate	19	Retainer	33	Hexagon socket set screw
6	Piston	20	Needle	34	Hexagon nut
7	Shoe	21	Ball bearing	35	Hexagon plug
8	Shoe holder	22	Needle bearing	36	Metal plug
9	Barrel holder	23	Oil seal	37	Nameplate
10	Swash plate	24	Snap ring	38	Lubrication port plate
11	Thrust bush	25	Snap ring	39	CAUTION plate
12	Spring holder	26	Snap ring	40	Rivet
13	Gasket	27	O-ring		
14	Spring C	28	O-ring		

List of Sealing Parts (Kit Model Number PSCS-100000)

Part No.	Part Name	Q'ty	PVS-0B-8	
			Size	Remarks
13	Packing	1	PSC46-100000	3 Bond
23	Oil seal	1	TCV-254511	N.O.K
27	O-ring	1	1B-P9	JIS B 2401
28	O-ring	1	1B-P11	JIS B 2401

Parts marked by an asterisk "*" are not available on the market. Consult your agent.

Performance Curves

Typical characteristics at hydraulic operating fluid kinematic viscosity of 32 mm²/s

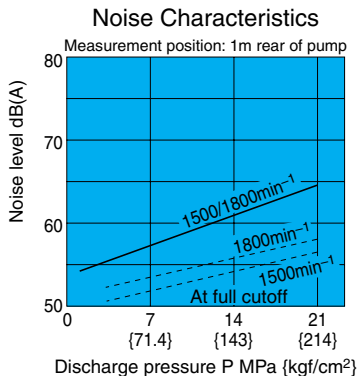
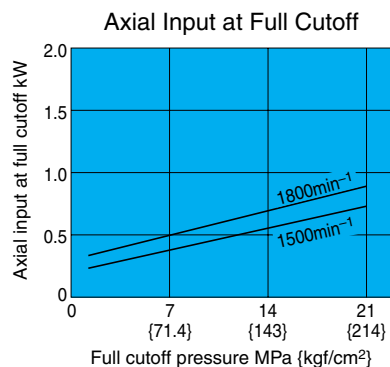
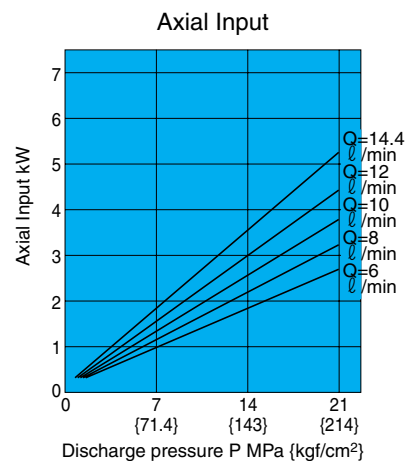
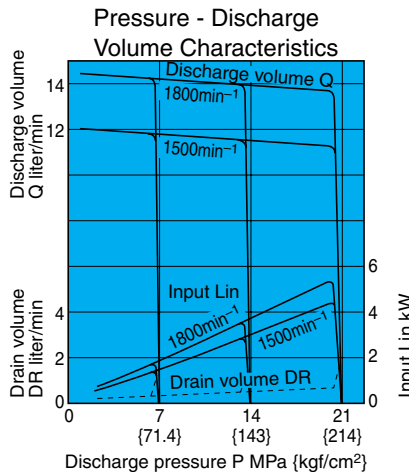
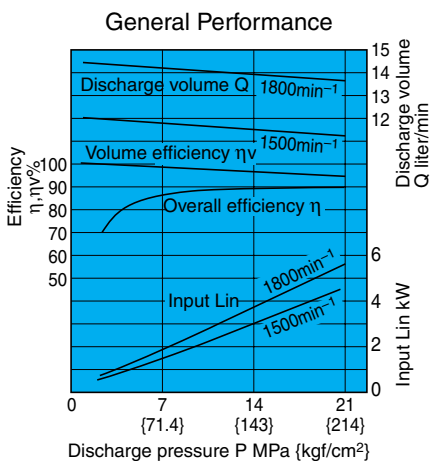

Installation Dimension Drawing

PVS-1B-16¹⁶22^{N*}-(Z)-12

(side port type)

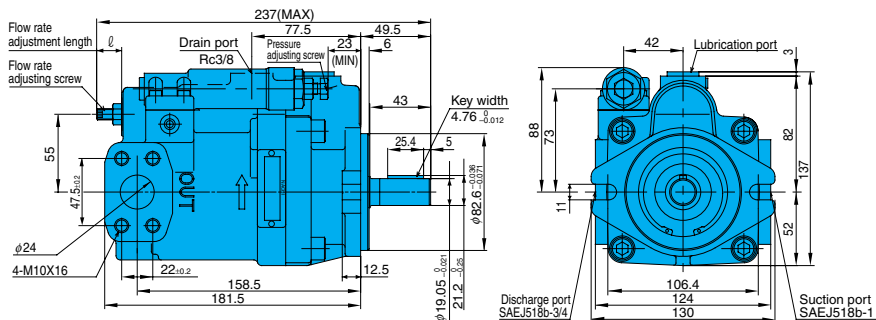

Relationship between flow rate adjustment length (l) and pump capacity (q)

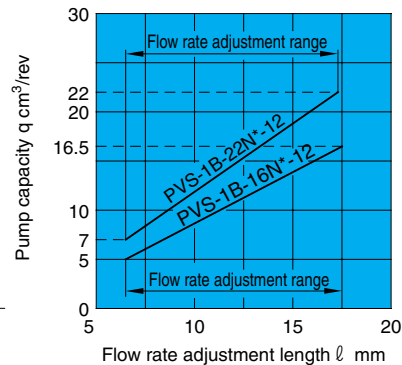

Set a flow rate adjustment length within the above range. Oil will leak if the pump is operated below the adjustment range lower limit.

(axial port type)

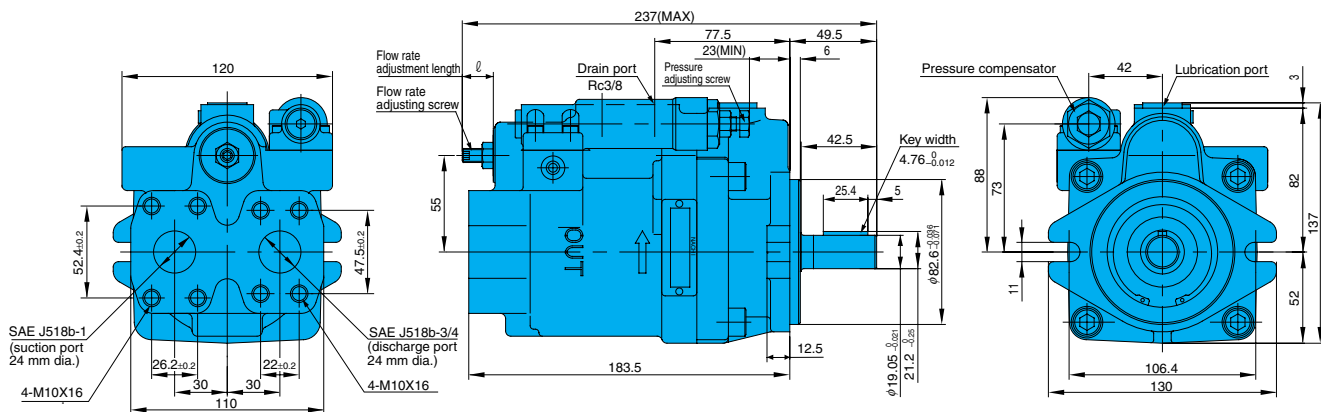

Cross-sectional Drawing

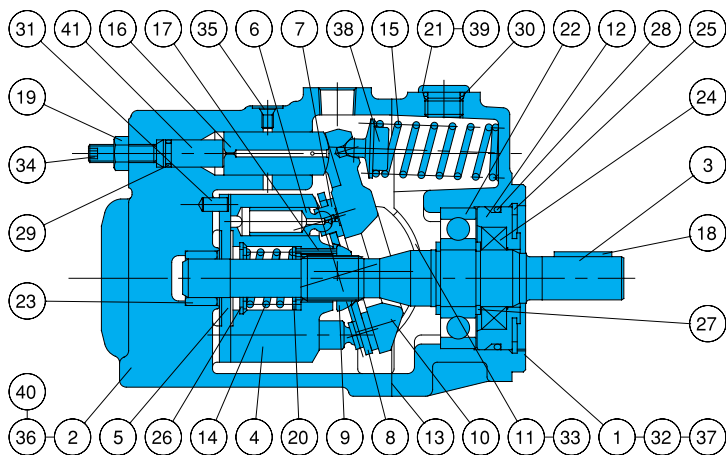

Part No.	Part Name	Part No.	Part Name
1	Body	22	Ball bearing
2	Case	23	Needle bearing
3	Shaft	24	Oil seal
4	Cylinder barrel	25	Snap ring
5	Valve plate	26	Snap ring
6	Piston	27	Snap ring
7	Shoe	28	O-ring
8	Shoe holder	29	O-ring
9	Barrel holder	30	O-ring
10	Swash plate	31	Pin
11	Thrust bush	32	Hexagon socket head bolt
12	Seal holder	33	Cross-recessed countersunk head screw
13	Gasket	34	Hexagon socket set screw
14	Spring C	35	Metal plug
15	Spring S	36	Nameplate
16	Control piston	37	CAUTION plate
17	Needle	38	Spring holder
18	Key	39	Lubrication port plate
19	Nut	40	Rivet
20	Retainer	41	Guide pin
21	Plug		

List of Sealing Parts (Kit Model Number PSS-101000-2A)

Part No.	Name	Q'ty	Size	Remarks
* 13	Gasket	1	PS46-101000	Nihon Gasket
24	Oil seal	1	TCN-254511	N.O.K
28	O-ring	1	1B-G55	JIS B 2401
29	O-ring	1	1B-P9	JIS B 2401
30	O-ring	1	1B-P14	JIS B 2401

Parts marked by an asterisk "*" are not available on the market. Consult your agent.

Performance Curves

Typical characteristics at hydraulic operating fluid kinematic viscosity of 32 mm²/s

PVS-1B-16N*(Z)-12

General Performance

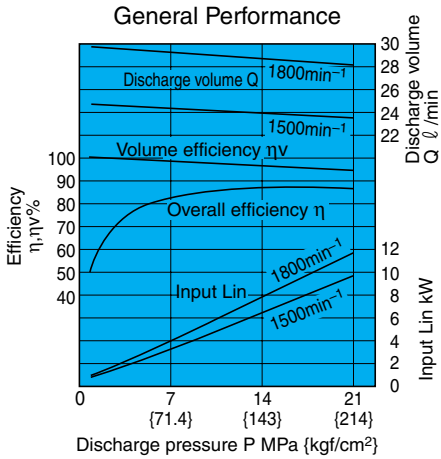

Pressure - Discharge Volume Characteristics

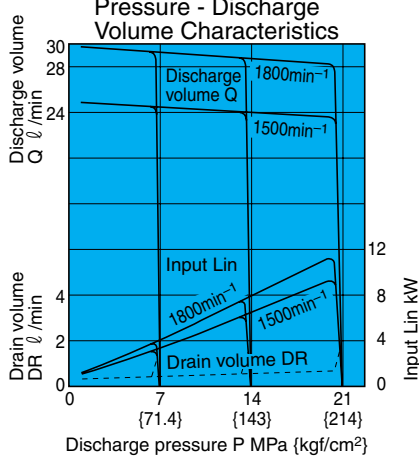

Axial Input

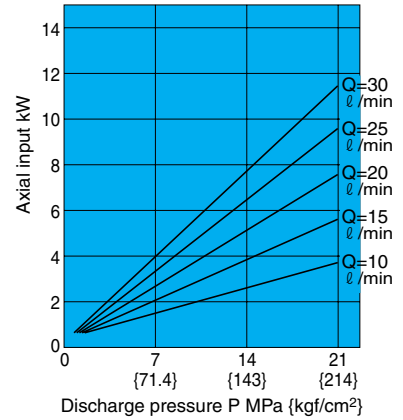

Axial Input at Full Cutoff

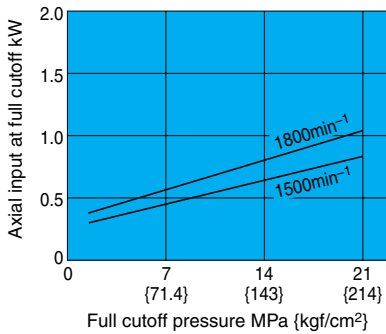

Noise Characteristics

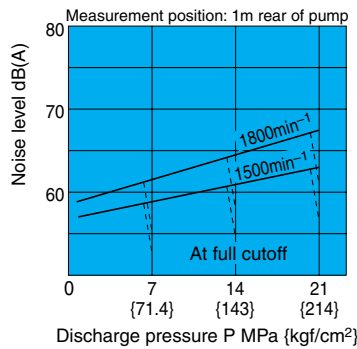

Oil Temperature Rise Characteristics PVS-1B-16N1-12

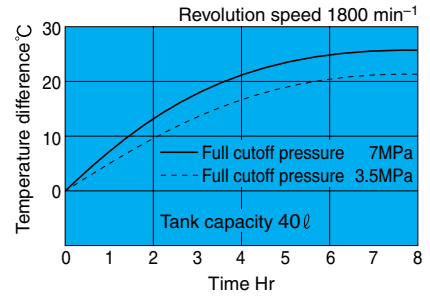

Performance Curves

Typical characteristics at hydraulic operating fluid kinematic viscosity of 32 mm²/s

PVS-1B-22N*(Z)-12

General Performance

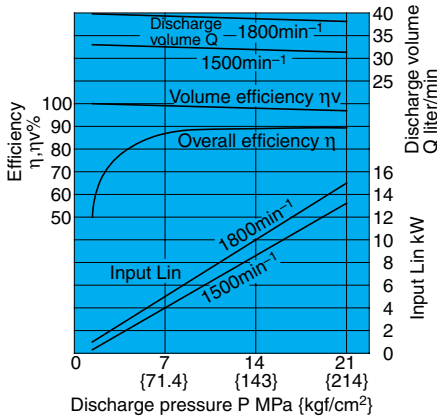

Pressure - Flow Rate Characteristics

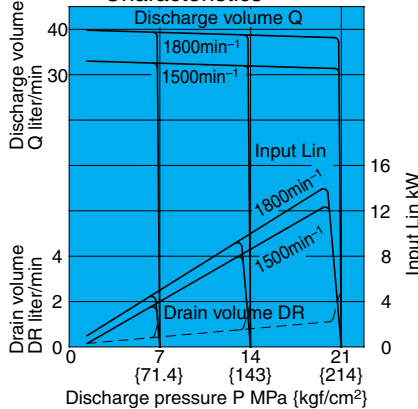

Oil Temperature Rise Characteristics PVS-1B-22N1-12

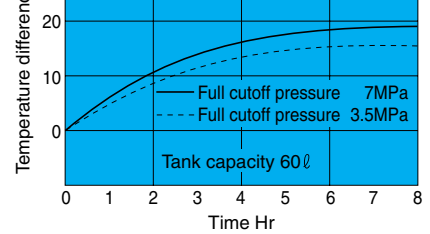

Axial input at full cutoff kW

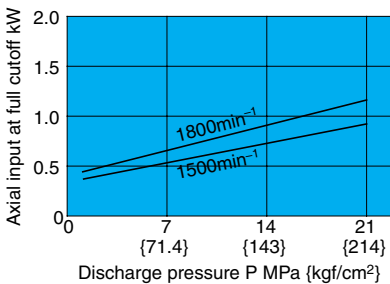

Noise Characteristics

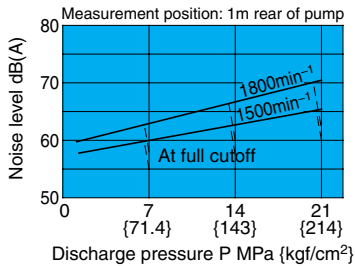

Axial Input

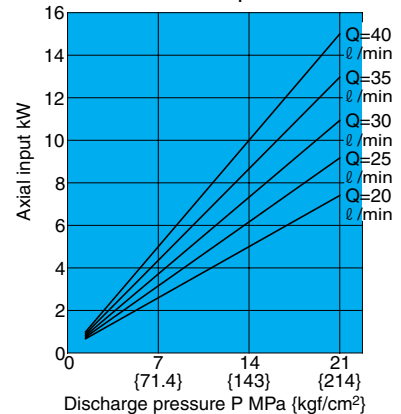

Installation Dimension Drawing

PVS-2B-³⁵/₄₅N*(Z)-12(20)

(side port type)

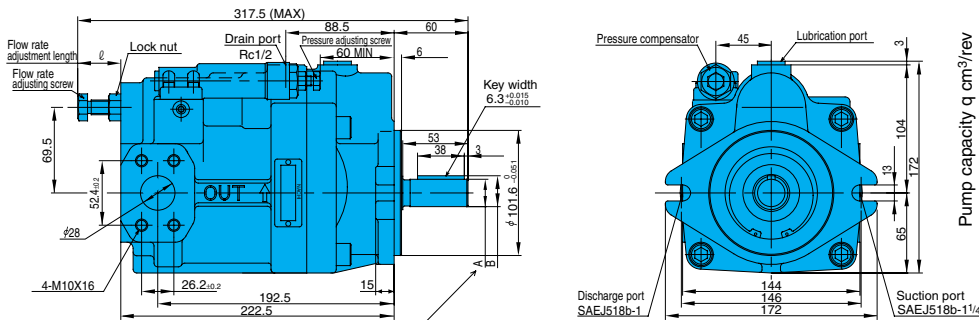

cm ³ /rev	Pressure Range	Design No.	A	B
35	0 to 3	12D	φ22.23 ⁰ / _{-0.021}	24.9 ⁰ / _{-0.5}
45	0 to 2	20D	φ25.385 ⁰ / _{-0.025}	27.85 ⁰ / _{-0.25}

Relationship between flow rate adjustment length (ℓ) and pump capacity (q)

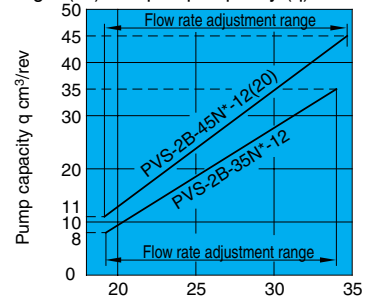

Flow rate adjustment length ℓ mm

Set a flow rate adjustment length within the above range. Oil will leak if the pump is operated below the adjustment range lower limit.

(axial port type)

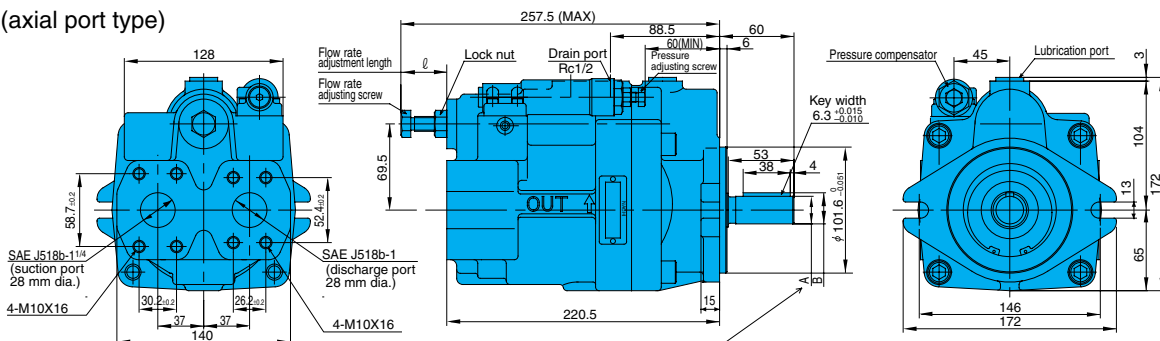

cm ³ /rev	Pressure Range	Design No.	A	B
35	0 to 3	12D	φ22.23 ⁰ / _{-0.021}	24.9 ⁰ / _{-0.5}
45	0 to 2	20D	φ25.385 ⁰ / _{-0.025}	27.85 ⁰ / _{-0.25}

Cross-sectional Drawing

PVS-2B-³⁵/₄₅N*(Z)-12

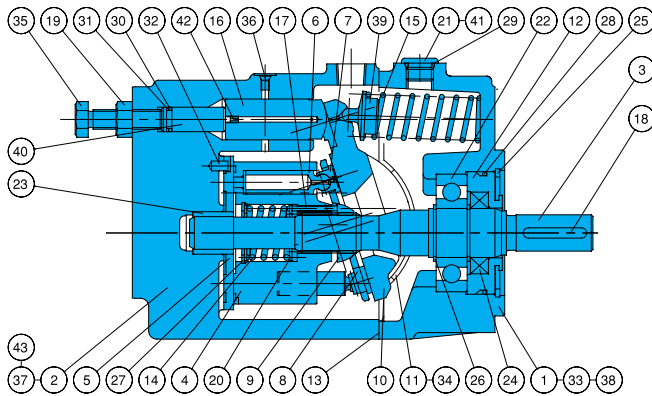

PVS-2B-45N3(Z)-20

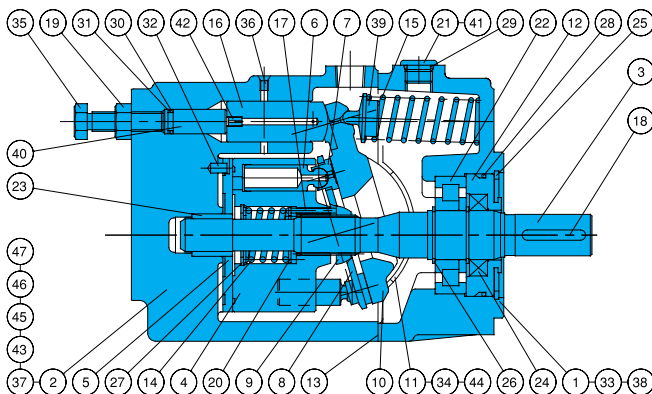

Part No.	Part Name	Part No.	Part Name	Part No.	Part Name
1	Body	16	Control piston	31	Backup ring
2	Case	17	Needle	32	Pin
3	Shaft	18	Key	33	Hexagon socket head bolt
4	Cylinder barrel	19	Nut	34	Cross-recessed countersunk head screw
5	Valve plate	20	Retainer	35	Flow rate adjusting screw
6	Piston	21	Plug	36	Metal plug
7	Shoe	22	Ball bearing	37	Nameplate
8	Shoe holder	23	Needle bearing	38	CAUTION plate
9	Barrel holder	24	Oil seal	39	Spring holder
10	Swash plate	25	Snap ring	40	Guide
11	Thrust bush	26	Snap ring	41	Lubrication port plate
12	Seal holder	27	Snap ring	42	Orifice
13	Gasket	28	O-ring	43	Rivet
14	Spring C	29	O-ring		
15	Spring S	30	O-ring		

List of Sealing Parts (Kit Model Number PSS-102000-2A)

Part No.	Part Name	Q'ty	PVS-2B-35/45		
			Size	Remarks	
*	13	Gasket	1	PS46-102000-0A	Nihon Gasket
*	24	Oil seal	1	TCN-305011Z	N.O.K
	28	O-ring	1	1B-G70	JIS B 2401
	29	O-ring	1	1B-P14	JIS B 2401
	30	O-ring	1	1B-P11	JIS B 2401
	31	Backup ring	1	T2-P11	JIS B 2407

Parts marked by an asterisk *** are not available on the market. Consult your agent.

Part No.	Part Name	Part No.	Part Name	Part No.	Part Name
1	Body	17	Needle	33	Hexagon socket head bolt
2	Case	18	Key	34	Cross-recessed countersunk head screw
3	Shaft	19	Nut	35	Flow rate adjusting screw
4	Cylinder barrel	20	Retainer	36	Metal plug
5	Valve plate	21	Plug	37	Nameplate
6	Piston	22	Roller bearing	38	CAUTION plate
7	Shoe	23	Needle bearing	39	Spring holder
8	Shoe holder	24	Oil seal	40	Guide
9	Barrel holder	25	Snap ring	41	Lubrication port plate
10	Swash plate	26	Snap ring	42	Orifice
11	Thrust bush	27	Snap ring	43	Rivet
12	Seal holder	28	O-ring	44	Orifice
13	Gasket	29	O-ring	45	Pin
14	Spring C	30	O-ring	46	O-ring
15	Spring S	31	Backup ring	47	Plug
16	Control piston	32	Pin		

List of Sealing Parts (Kit Model Number PSBS-102220)

Part No.	Part Name	Q'ty	PVS-2B-45N3		
			Size	Remarks	
*	13	Gasket	1	PS46-102000-0A	Nihon Gasket
*	24	Oil seal	1	TCN-305011Z	N.O.K
	28	O-ring	1	1B-G70	JIS B 2401
	29	O-ring	1	1B-P14	JIS B 2401
	30	O-ring	1	1B-P11	JIS B 2401
	46	O-ring	2	1B-P5	JIS B 2401
	31	Backup ring	1	T2-P11	JIS B 2407

Parts marked by an asterisk *** are not available on the market. Consult your agent.

Performance Curves

Typical characteristics at hydraulic operating fluid kinematic viscosity of 32 mm²/s

PVS-2B-35N^{*}-(Z)-12

A

Piston Pumps

General Performance

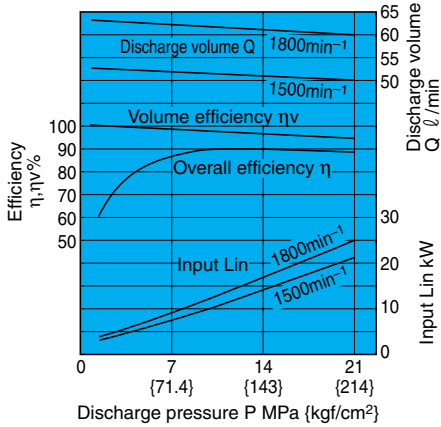

Pressure - Discharge Volume Characteristics

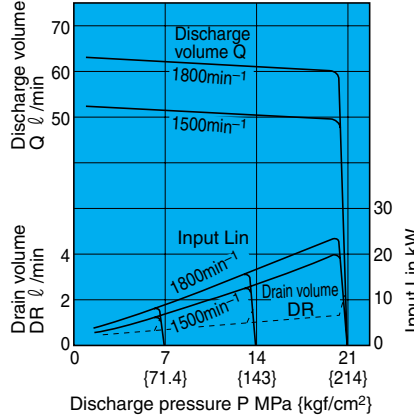

Axial Input

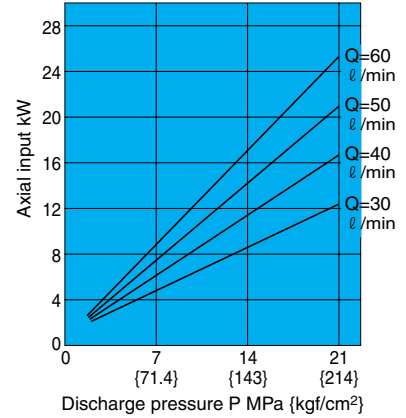

Axial Input at Full Cutoff

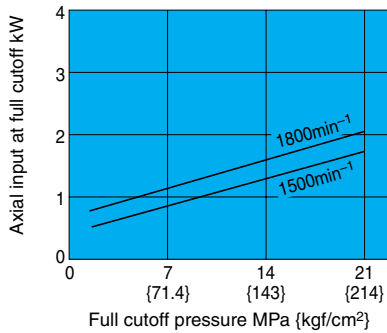

Noise Characteristics

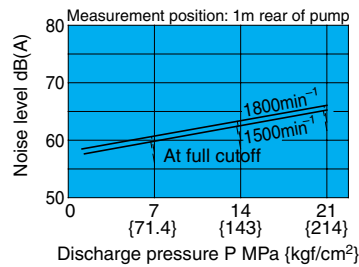

Performance Curves

Typical characteristics at hydraulic operating fluid kinematic viscosity of 32 mm²/s

PVS-2B-45N^{*}-(Z)-12(20)

General Performance

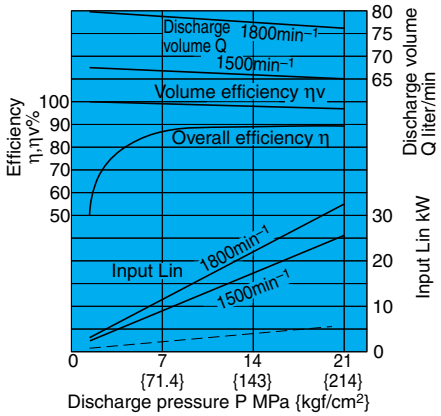

Pressure - Discharge Volume Characteristics

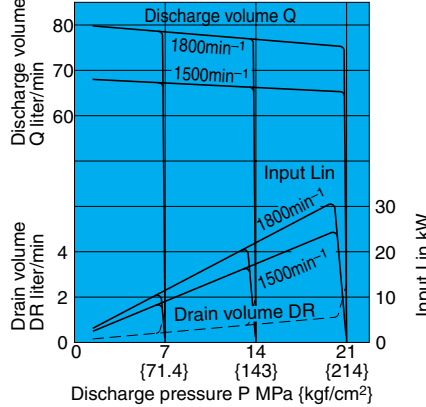

Axial Input

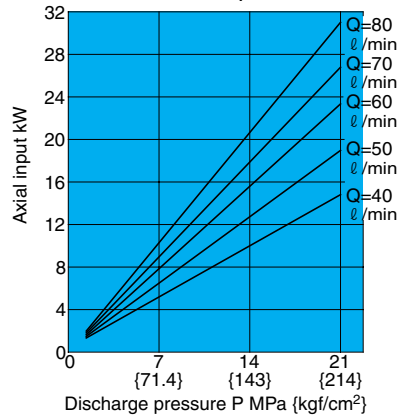

Axial Input at Full Cutoff

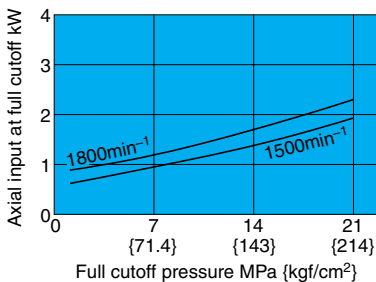

Noise Characteristics

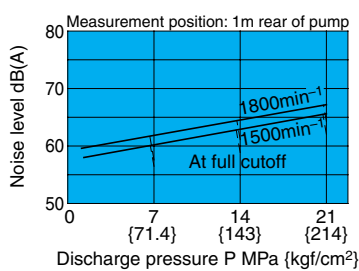

Response Performance

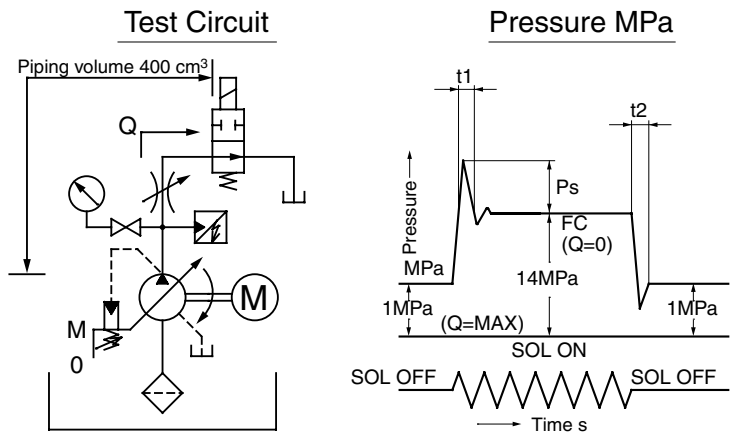

Model No.	Response Time (s)		Surge Pressure MPa(kgf/cm²)
	t ₁	t ₂	P _s
PVS-0B-8	0.03 to 0.04	0.04 to 0.06	2 to 4{20.4 to 40.8}
PVS-1B-16	0.05 to 0.06	0.07 to 0.08	4 to 7{40.8 to 71.4}
PVS-1B-22	0.05 to 0.06	0.07 to 0.08	5 to 8{51 to 81.6}
PVS-2B-35	0.05 to 0.06	0.05 to 0.07	6 to 9{61.2 to 91.8}
PVS-2B-45	0.05 to 0.06	0.05 to 0.07	6 to 9{61.2 to 91.8}

Response performance changes according to pipe volume and size.
Use an anti-surfing valve to prevent surge voltage.

Pressure Compensator

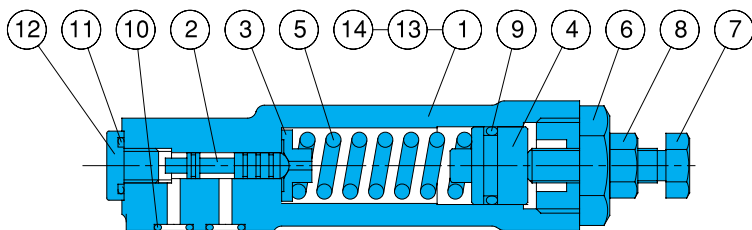

Part No.	Part Name	Part No.	Part Name
1	Body	8	Nut
2	Spool	9	O-ring
3	Holder	10	O-ring
4	Plunger	11	O-ring
5	Spring	12	Plug
6	Retainer	13	Plug
7	Pressure adjusting bolt	14	Mounting bolt

List of Sealing Parts

Part No.	Name	Q'ty	Size
			For 0B, 1B, 2B
9	O-ring	1	1A-P14
10	O-ring	3	1B-P6
11	O-ring	1	1B-P10

Note) O-ring 1A/B-** refers to JIS B2401-1A/B.

Pressure Compensation Type

(remote control mode)

Explanation of model No.: **PVS - 0 B - 8 P * - 30**

Design No.
 30: PVS-0*
 12: PVS-1*, PVS-2*
 20: PVS-2*-45P3 only

Pressure adjustment range
 0: 2- 3.5MPa {20.4- 35.7kgf/cm²}
 1: 2- 7MPa {20.4- 71.4kgf/cm²}
 2: 3-14MPa {30.6-143kgf/cm²}
 3: 3-21MPa {30.6-214kgf/cm²}

P: Pressure compensation type (remote control mode)

Max. pump capacity (cm³/rev)
 Nominal 8, 16, 22, 35, 45

Pump size 0, 1, 2

P-Q Characteristics

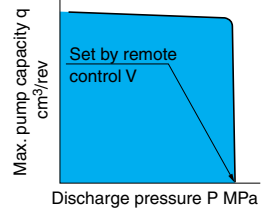

Installation Dimension Drawing

The ZR-T02*-5895* is the recommended remote control valve. Provide piping to the remote control valve at a pipe volume of 150 cm³ or less.

PVS-0B-8P*-30

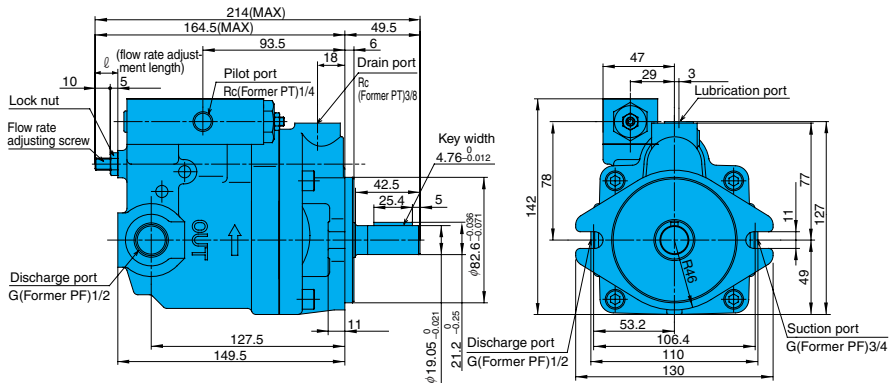

PVS-1B-16P*-12

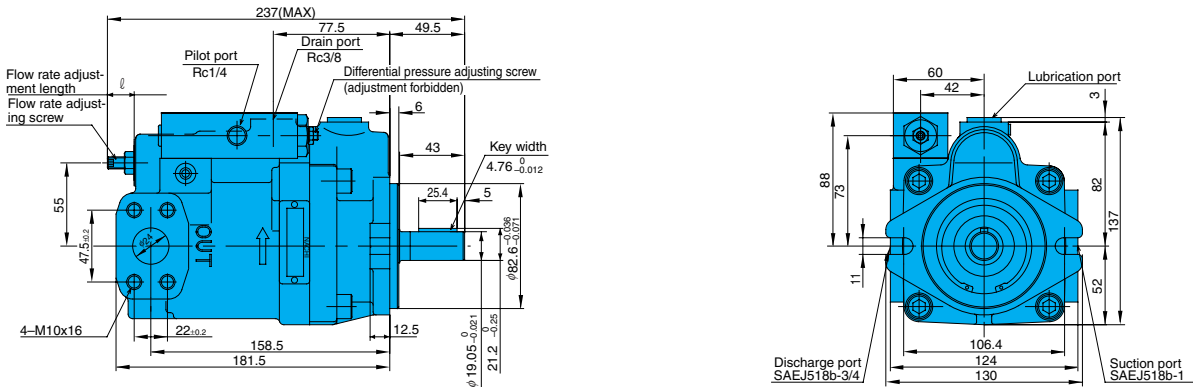

PVS-2B-35P*-12(20)

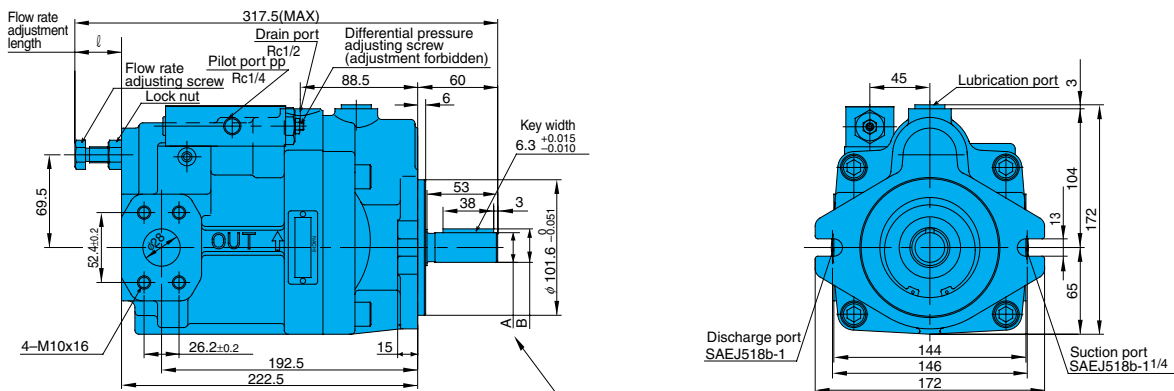

cm ³ /rev	Pressure Range	Design No.	A	B
35	0 to 3	12D	φ22.23 ⁰ _{-0.021}	24.9 ⁰ _{-0.5}
45	0 to 2	3	φ25.385 ⁰ _{-0.025}	27.85 ⁰ _{-0.25}

A
Piston Pumps

2-pressure, 2-flow Rate Control Type

Explanation of model No.: **PVS - 1 B - 16 N 3 Q 1 - 12**

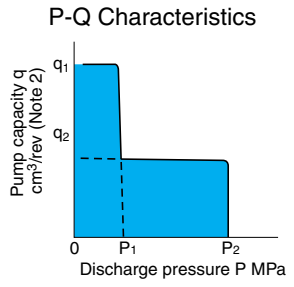
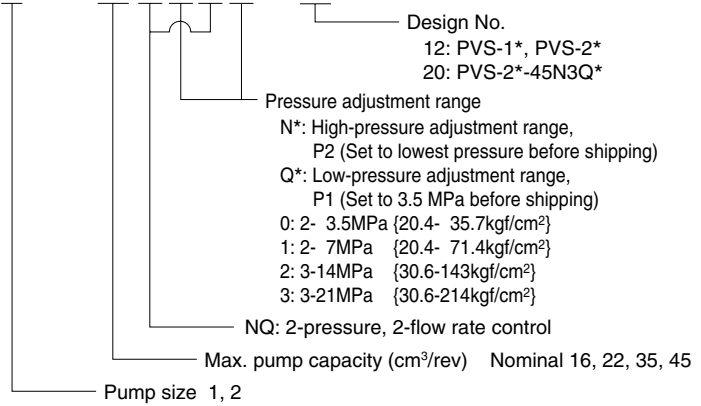

Installation Dimension Drawing

PVS-1B-¹⁶/₂₂N*Q*-12

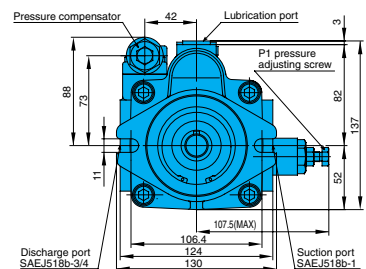
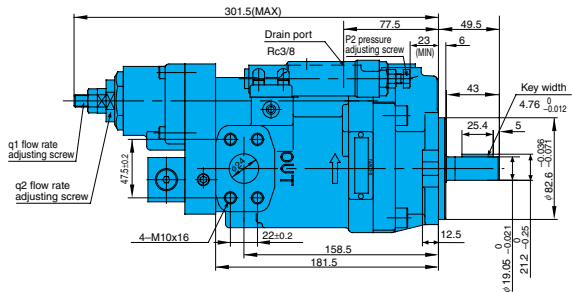

PVS-2B-³⁵/₄₅N*Q*-12(20)

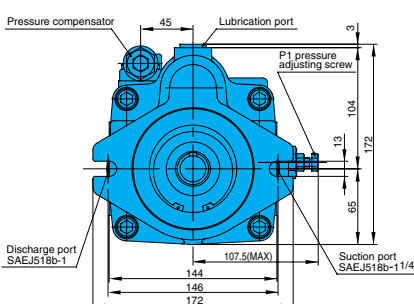
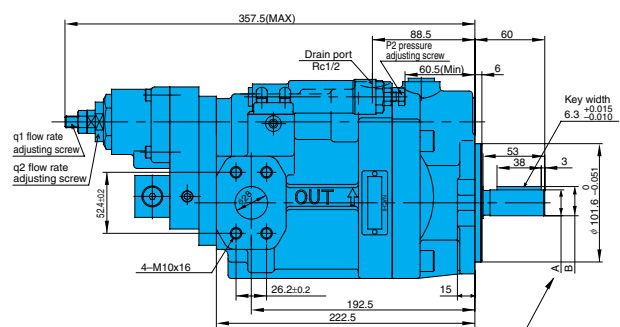

cm ³ /rev	Pressure Range	Design No.	A	B
35	0 to 3	12D	φ 22.23 ⁰ / _{-0.021}	24.9 ⁰ / _{-0.5}
45	0 to 2	20D	φ 25.385 ⁰ / _{-0.025}	27.85 ⁰ / _{-0.25}

Pump Model No.	q _e Adjustment Range (cm ³ /rev)	Default q _e (Setting cm ³ /rev)
PVS-1B-16	2 to 10	3.3
PVS-1B-22	2 to 13	4.4
PVS-2B-35	2 to 19	7
PVS-2B-45	3 to 24	9

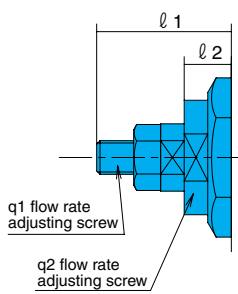

Flow adjustment length and pump capacity

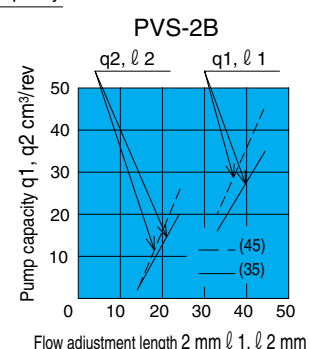
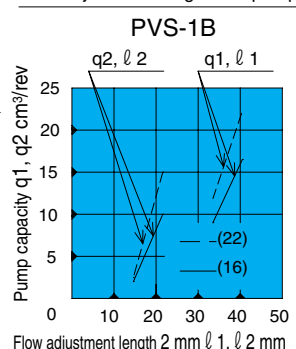

Note 1) The setting range of maximum pump capacity q₁ varies according to the setting of q_e.

Note 2) Overall efficiency at a low flow rate is worse than at the maximum flow rate. Pay attention to this when selecting the motor capacity for the drive.

Solenoid Cutoff Control Type

Explanation of model No.: **PVS - 1 B - 16 R 2 S 1 - 12**

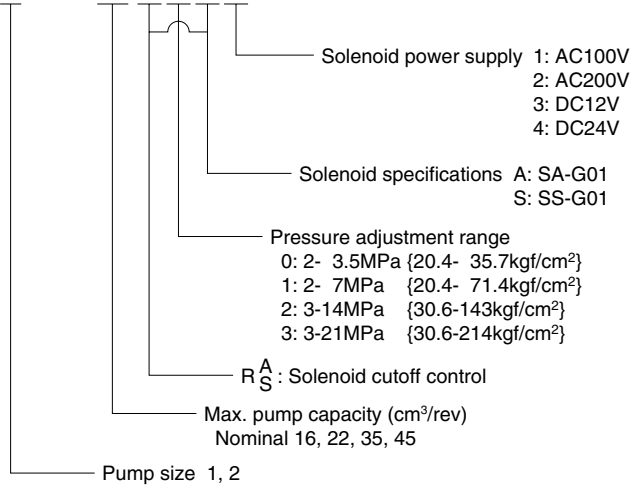

P-Q Characteristics

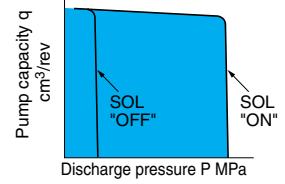

Installation Dimension Drawing

PVS-1B-16^RA^{*}-12_S

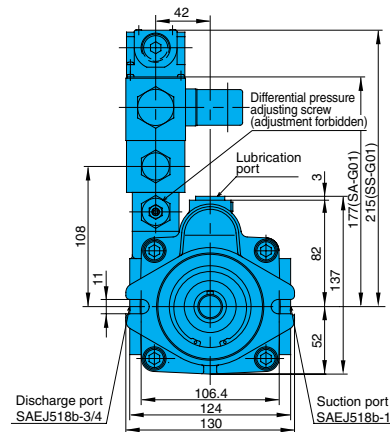
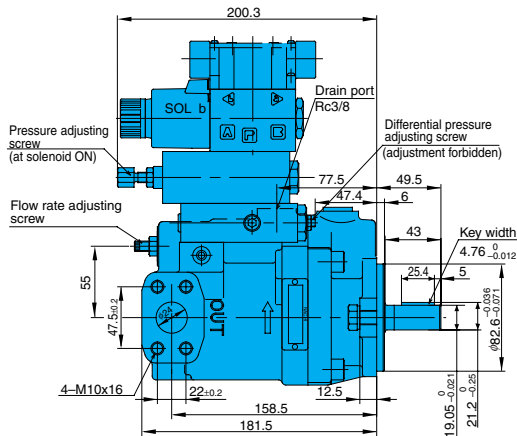

PVS-2B-35^RA^{*}-12(20)_S

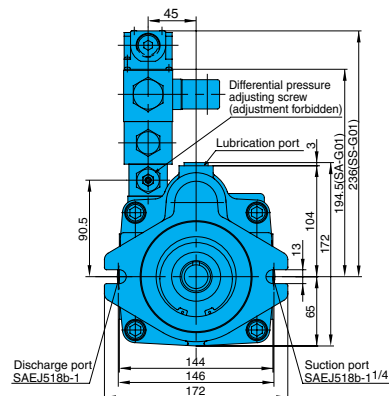
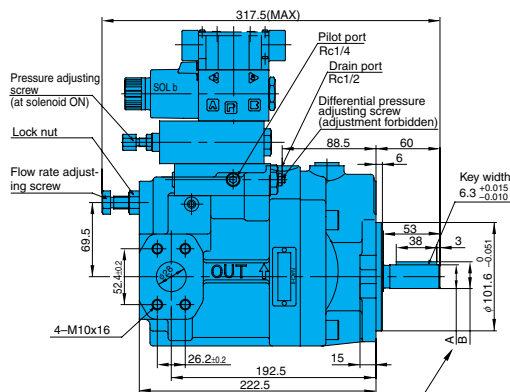

cm ³ /rev	Pressure Range	Design No.	A	B
35	0 to 3	12D	φ22.23 ⁰ _{-0.021}	24.9 ⁰ _{-0.5}
45	0 to 2	3	φ25.385 ⁰ _{-0.025}	27.85 ⁰ _{-0.25}

■ The coil surface temperature increases if this pump is kept continuously energized.
Do not touch the surface of the coil directly with your hands.

2-pressure Control Type

Explanation of model No.: **PVS - 1 B - 16 W 2 S 1 - 12**

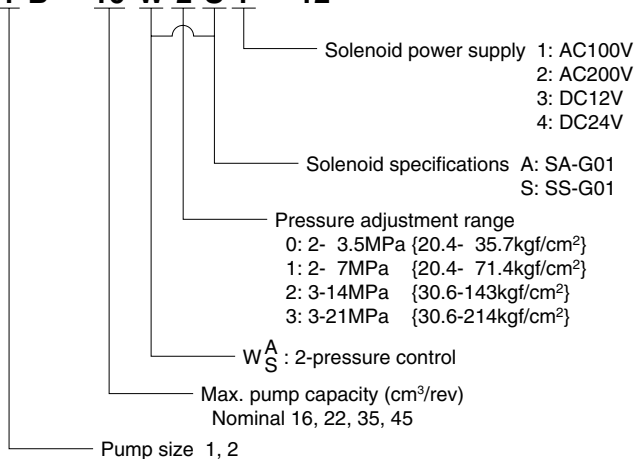

P-Q Characteristics

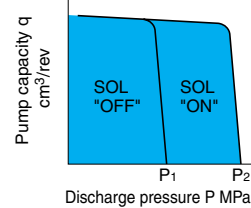

Installation Dimension Drawing

PVS-1B-¹⁶₂₂W^A_S-12

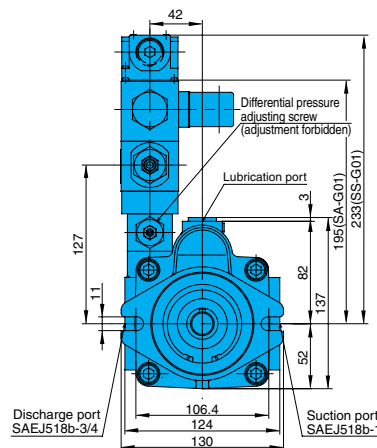
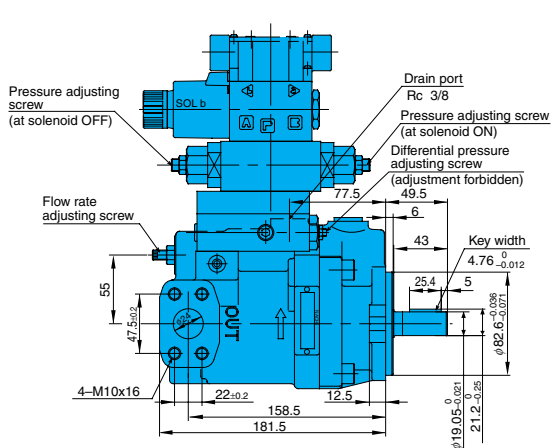

PVS-2B-³⁵₄₅W^A_S-12(20)

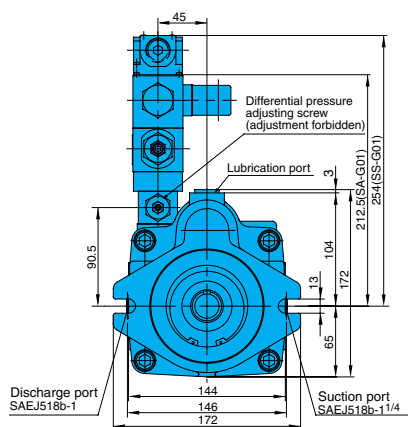
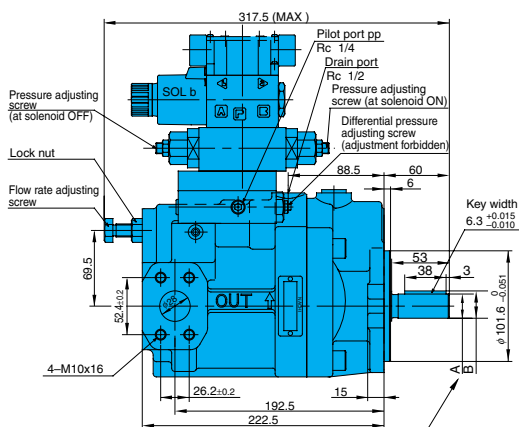

cm ³ /rev	Pressure Range	Design No.	A	B
35	0 to 3	12D	φ 22.23 ⁰ _{-0.021}	24.9 ⁰ _{-0.5}
45	0 to 2	3	φ 25.385 ⁰ _{-0.025}	27.85 ⁰ _{-0.25}

■ The coil surface temperature increases if this pump is kept continuously energized.
 Do not touch the surface of the coil directly with your hands.

2-pressure, 2-flow rate Control Type w/ Solenoid Cutoff

A
Piston Pumps

Explanation of model No.: **PVS - 1 B - 16 RQ 2 S 1 - 12**

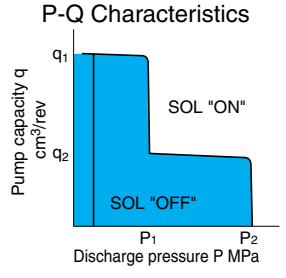
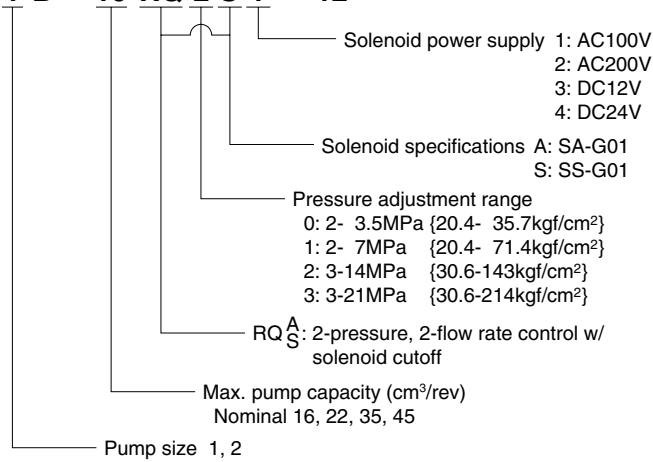

Installation Dimension Drawing

PVS-1B-16RQ^A-12
 S

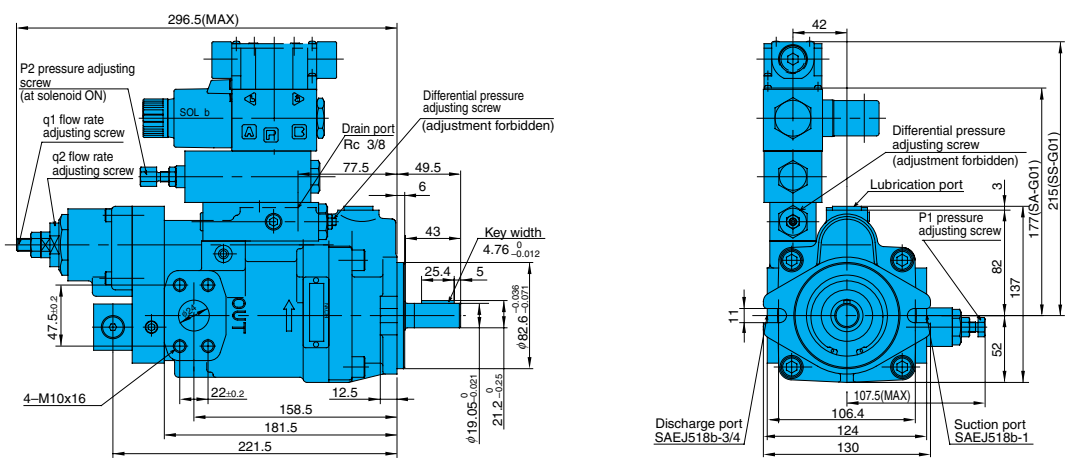

PVS-2B-35RQ^A-12(20)
 S

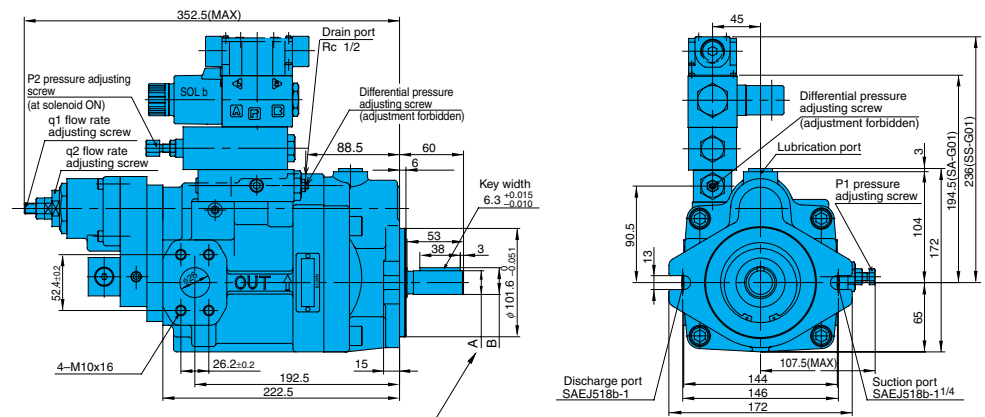

cm ³ /rev	Pressure Range	Design No.	A	B
35	0-3 0-2	12D	φ 22.23 ⁰ _{-0.021}	24.9 ⁰ _{-0.5}
45	3	20D	φ 25.385 ⁰ _{-0.025}	27.85 ⁰ _{-0.25}

■ The coil surface temperature increases if this pump is kept continuously energized.
 Do not touch the surface of the coil directly with your hands.

Foot Mounting Kit

A
Piston Pumps

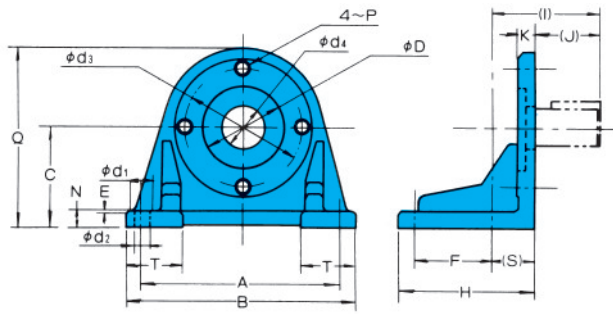

Kit Model No.	Applicable Pump Model No.	Accessories				Dimensions				
		Bolt	Q'ty	Washer	Q'ty	A	B	C	E	F
IHM-2-10	PVS-0B PVS-1B	TB-10×30	2	WP-10	2	127	152.5	69.8	1	50.8
IHM-4-10	PVS-2B	TB-12×30	2	WP-12	2	220.7	246	107.95	1	114.3

Kit Model No.	Dimensions														Weight kg
	H	(I)	(J)	K	N	P	Q	(S)	T	ϕD	ϕd_1	ϕd_2	ϕd_3	ϕd_4	
IHM-2-10	96	64.5	32	17.5	13	M10	135	32.5	36.5	82.6	22	11	106.4	50	2.0
IHM-4-10	140	56.7	44	16	16	M12	195.5	12.7	53	101.6	22	11	146	40	5.5

When only the mounting feet are required, the pump mounting bolts, washers and other parts are sold together as the Foot Mounting Kit.

Coupling kit

Kit for PVS-0B: PSCF-100000

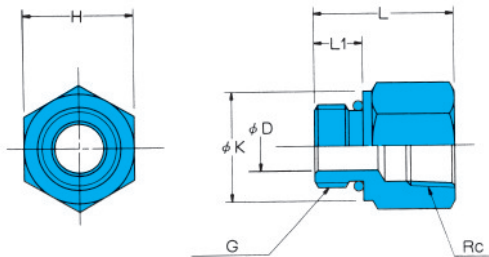

Applicable Pump Model No.	PVS-0B-8	
Plunger Kit model No.	Suction port	Discharge port
L	46	40
L ₁	16	14
ϕK	$\phi 36$	$\phi 27$
ϕD	$\phi 16$	$\phi 12$
H	36	27
G screw size	G3/4	G1/2
Rc screw size	Rc3/4	Rc1/2
O-ring size	1B-P24	1B-P18

- (Notes)
1. Joints are on sale in the Joint Kit which includes O-rings.
 2. The dimensions of the O-ring seal section on the connector conforms with JIS B2351.
 3. O-ring 1B/B-** refers to JIS B2401-1B.

Piping Flange Kit

For PVS-1B, 2B

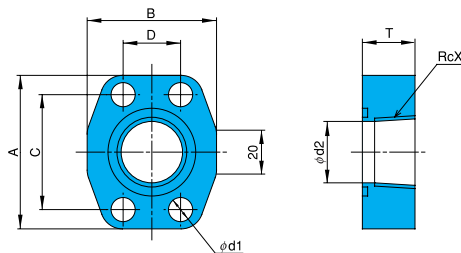

Applicable Pump Model No.	PVS-1B-16/22		PVS-2B-35/45	
	PSF-101000		PSF-102000	
Plunger Kit model No.	Suction port	Discharge port	Suction port	Discharge port
A	70	65	79	70
B	59	52	73	59
C	52.4	47.5	58.7	52.4
D	26.2	22.0	30.2	26.2
T	24	24	28	24
ϕd_1	$\phi 11$	$\phi 11$	$\phi 11$	$\phi 11$
ϕd_2	$\phi 28$	$\phi 22$	$\phi 37$	$\phi 28$
X	1	3/4	1-1/4	1
Mounting bolt	TH-10×40	TH-10×40	TH-10×45	TH-10×40
Washer	WS-B-10	WS-B-10	WS-B-10	WS-B-10
O-ring	1B-G35	1B-G30	1B-G45	1B-G35
Weight kga	0.6	0.5	0.75	0.6

- (Notes)
1. The piping flange is on sale in the Flange Kit which includes mounting bolts, washers and O-rings.
 2. O-ring 1B/B-** refers to JIS B2401-1B.
 3. For details on tightening torque, see page C-11.